

# KOEN

# S136-REG2S

A	B	C	D	A	B	C	D		
1	S136-011	396	185	4/4	13	S136-410	905	68	1/4
2	S136-012	396	185	4/4	14	S136-411	809	50	1/4
3	S136-127	1983	371	1/4	15	S136-584	939	65	3/4
4	S136-128	1983	371	1/4	16	S136-585	2000	65	3/4
5	S136-129	155	371	2/4	17	S136-586	2000	65	3/4
6	S136-139	1899	371	1/4	18	S136-913	359	348	2/4
7	S136-207	938	371	1/4	19	S136-914	1925	465	1/4
8	S136-307	905	371	1/4	20	ZS2-511	350	120	2/4
9	S136-309	445	371	2/4	21	ZS2-512	350	120	2/4
10	S136-310	445	371	2/4	22	ZS2-5564	348	120	2/4
11	S136-312	443	371	2/4					
12	S136-326	444	371	2/4					

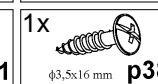
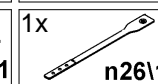
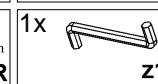
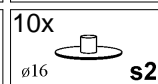
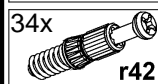
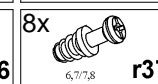
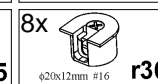
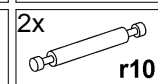
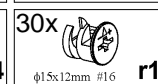
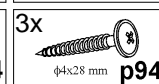
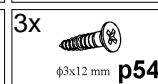
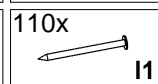
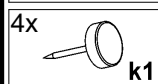
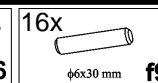
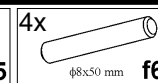
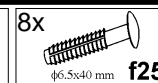
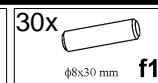
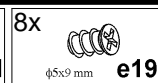
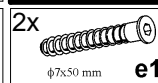
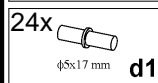
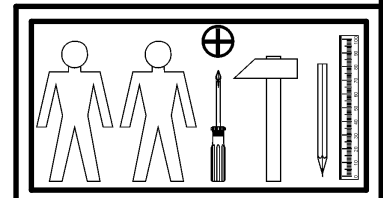
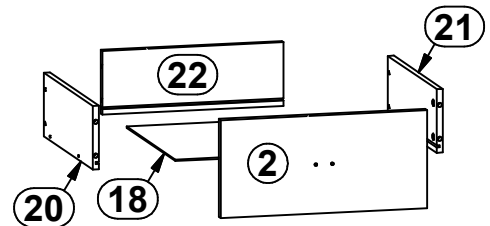
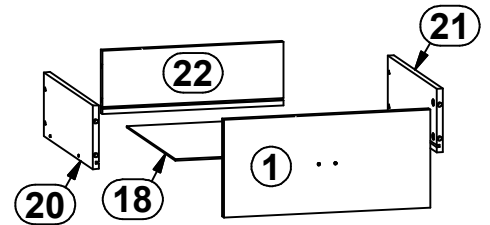
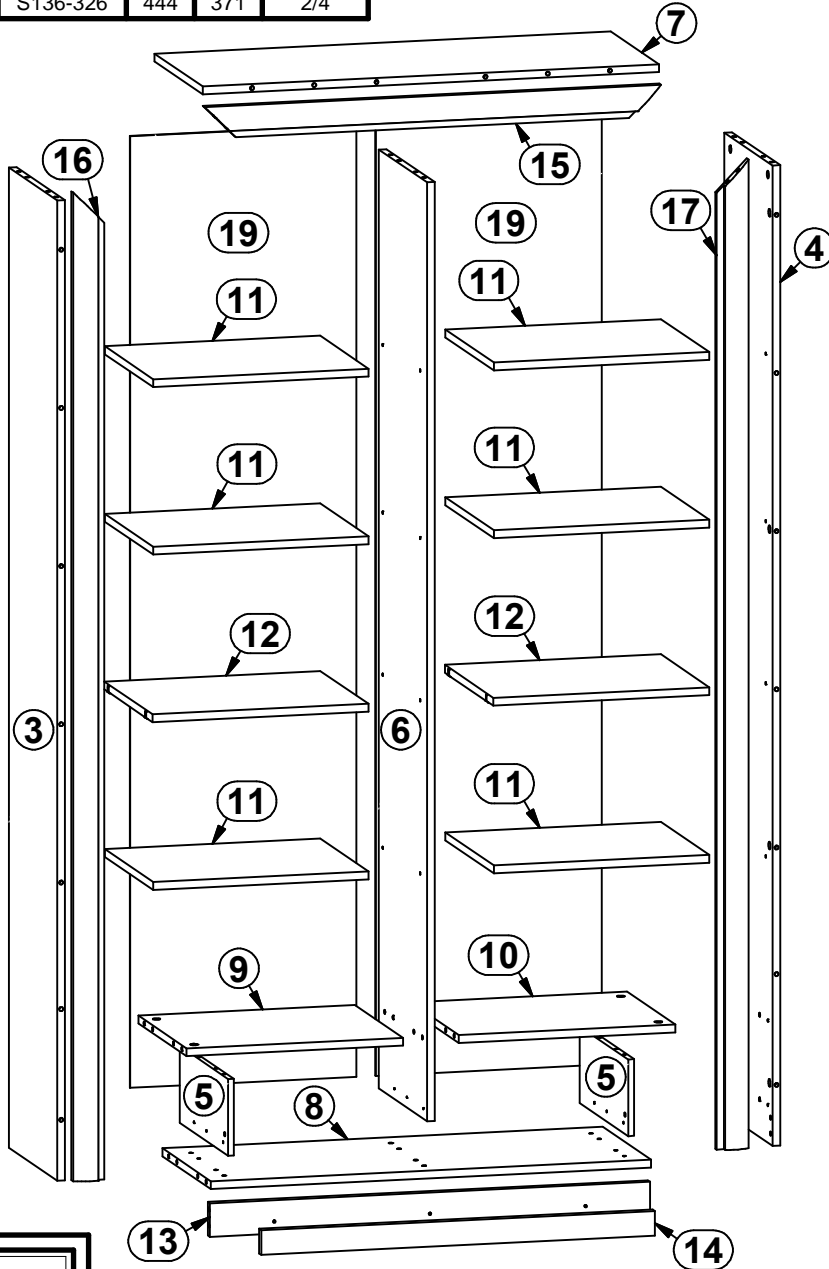
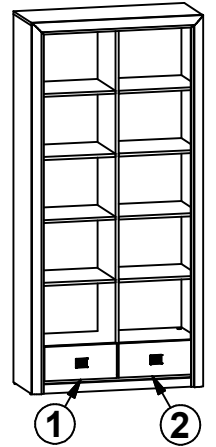

# 1

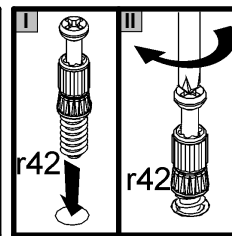
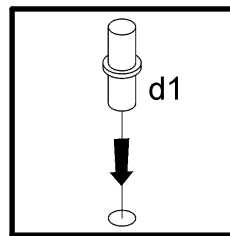
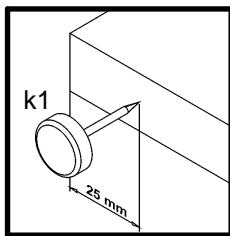
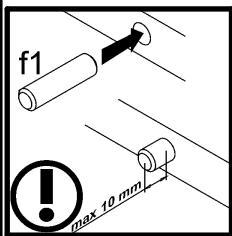
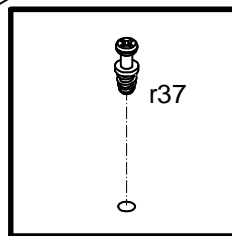
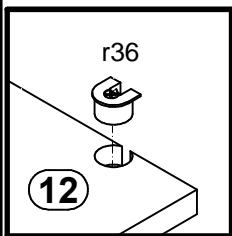
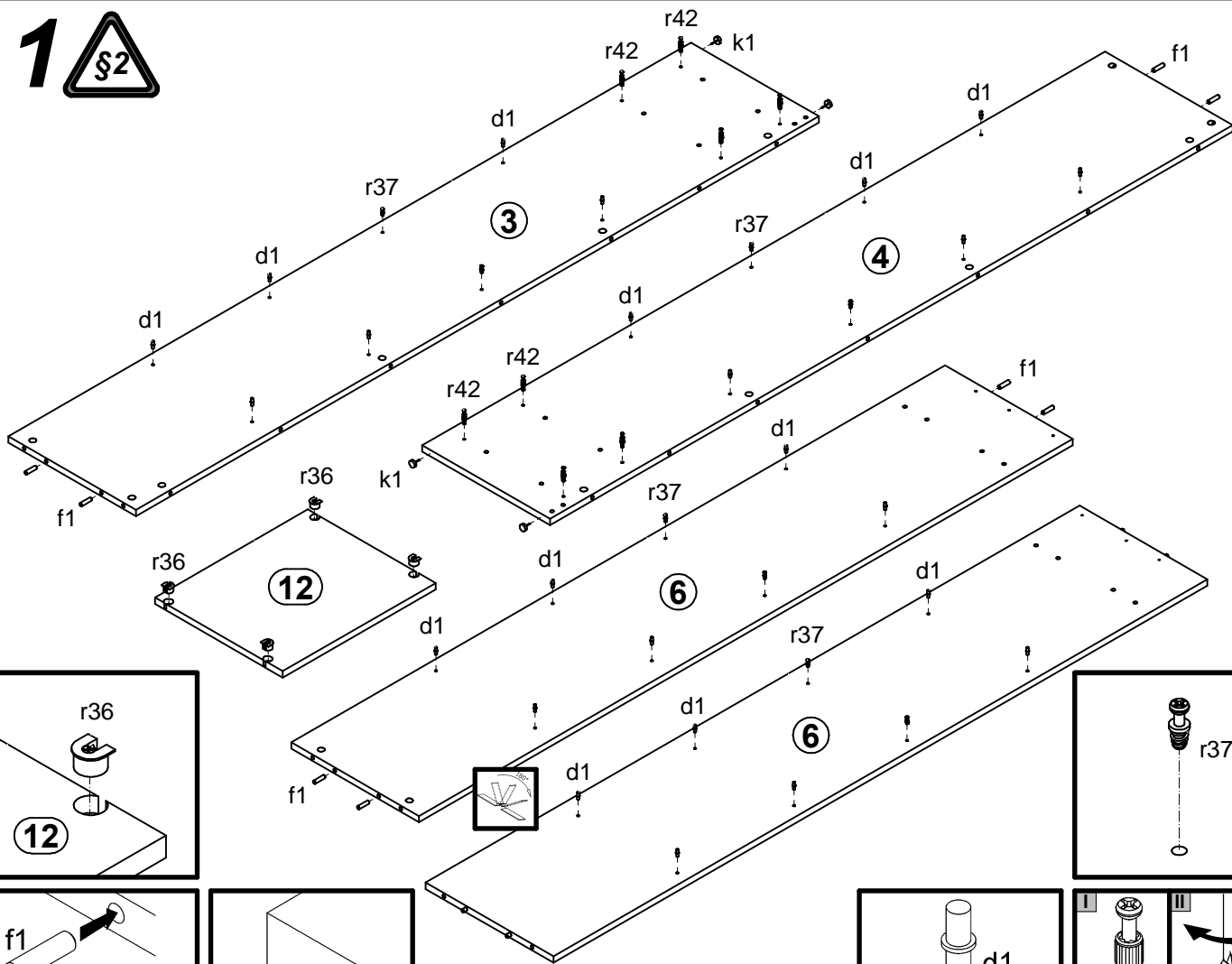

# 2

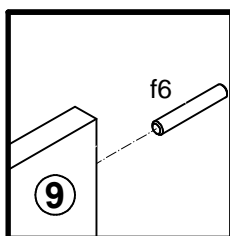
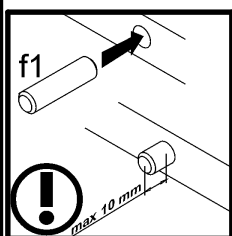
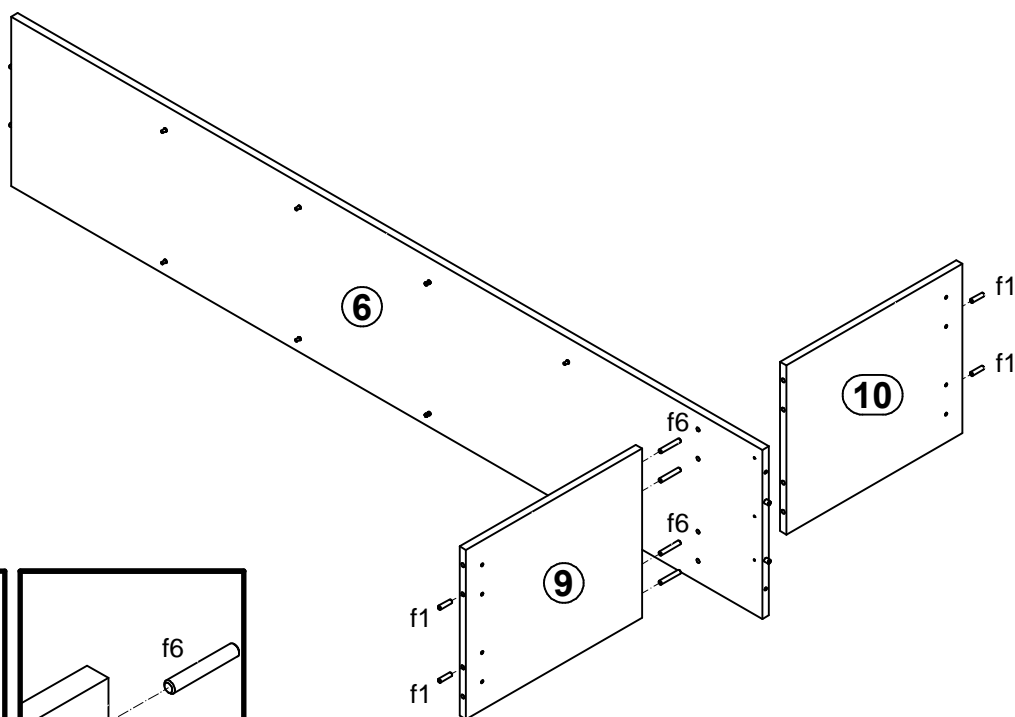

# 3

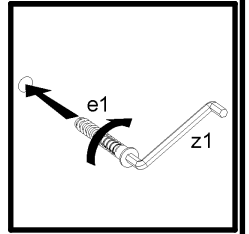
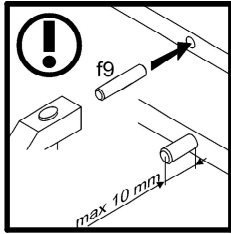
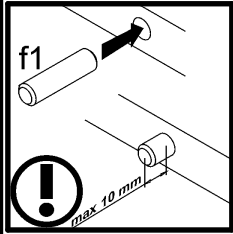
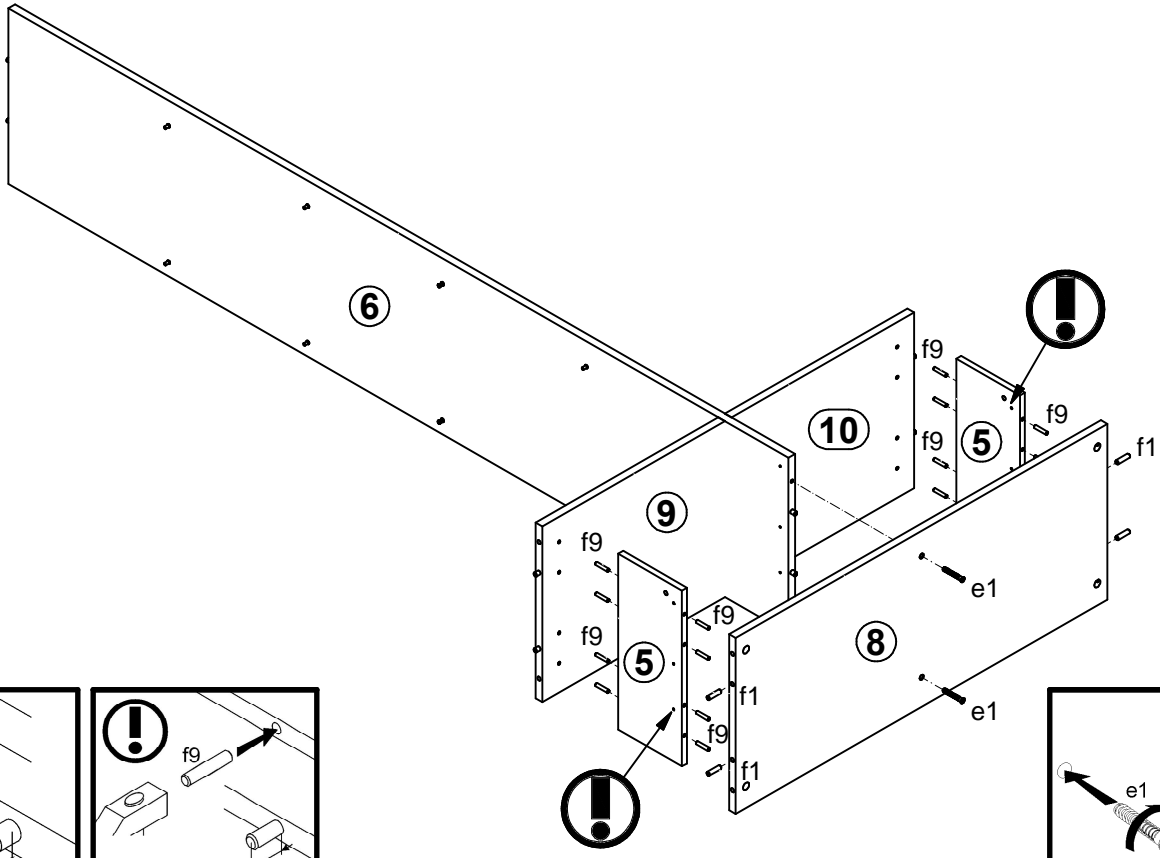

# 4

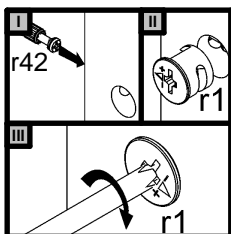
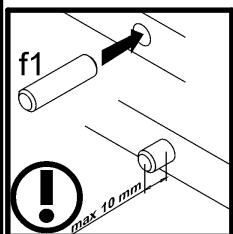
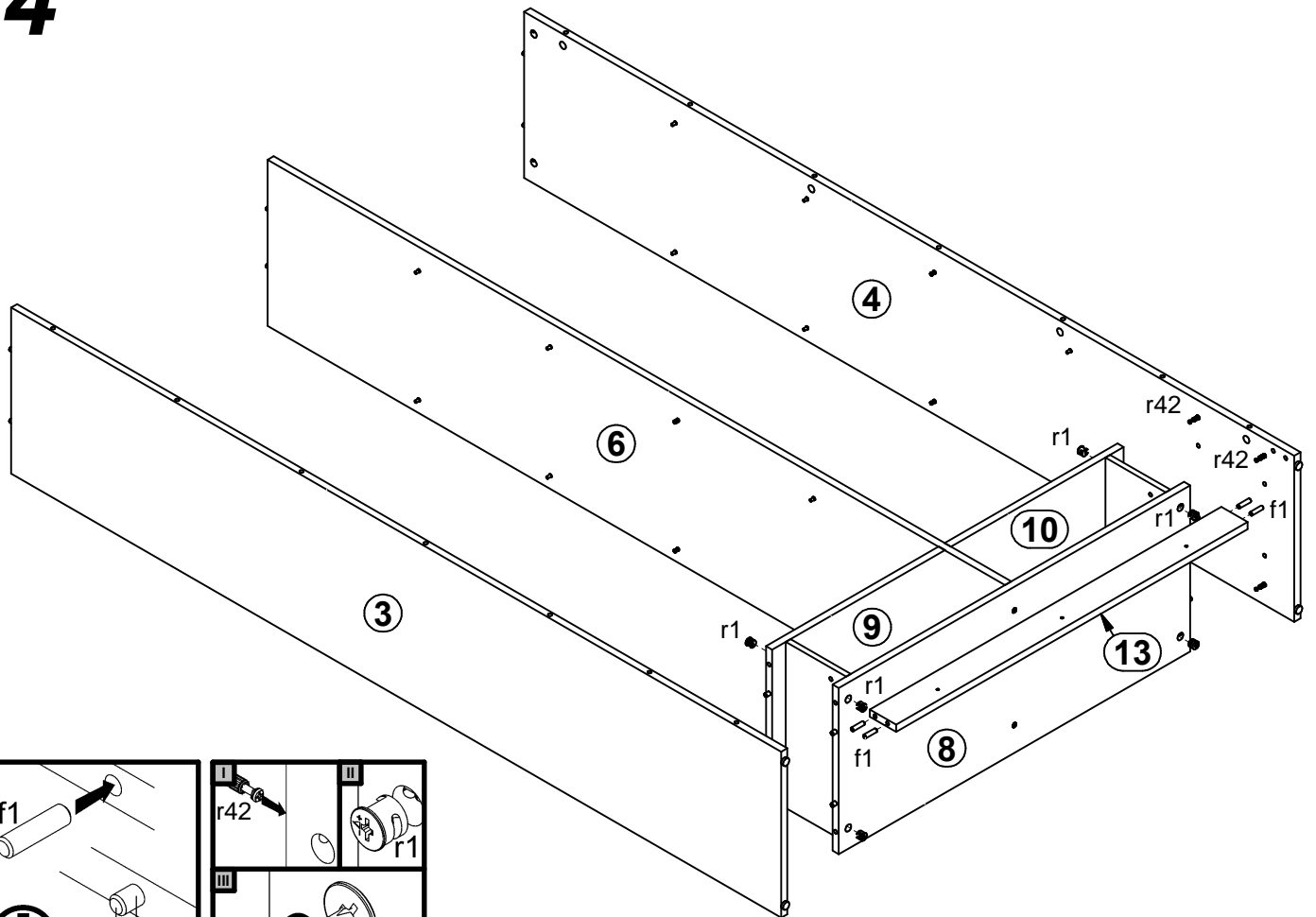

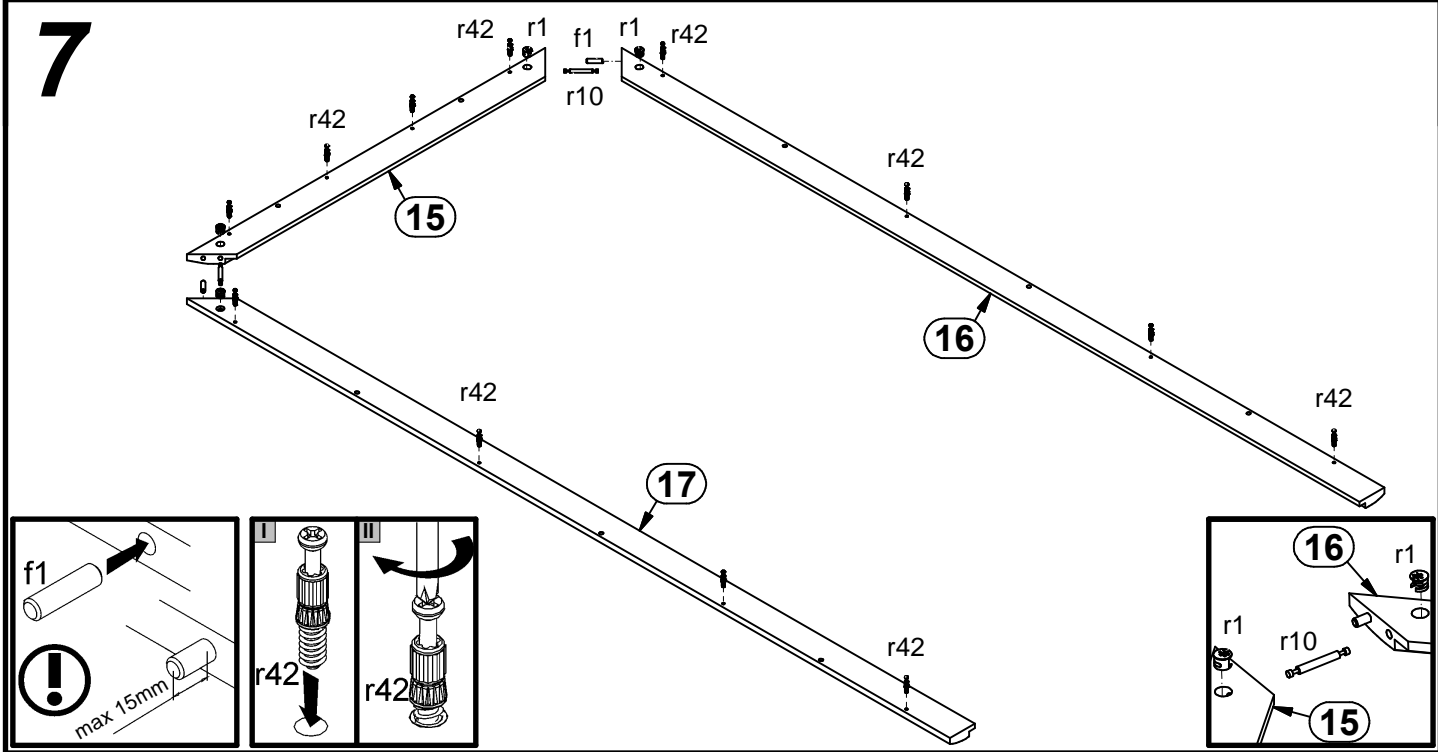
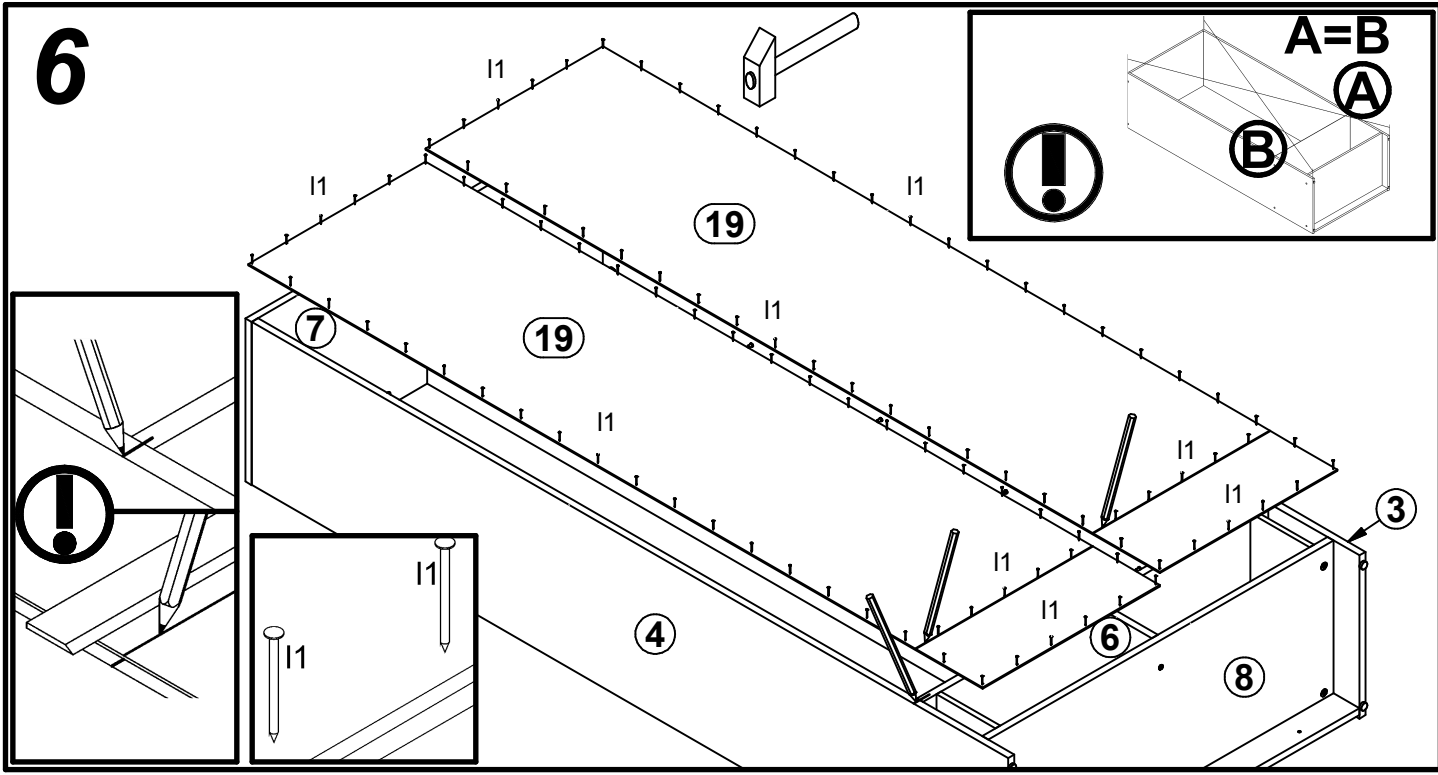
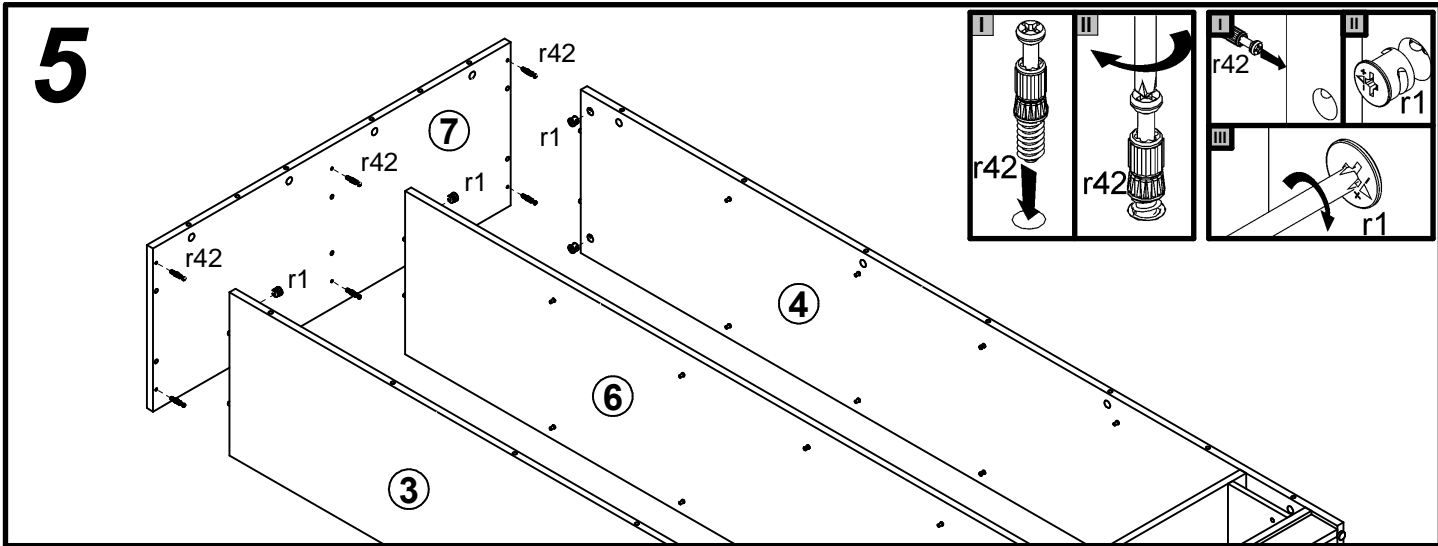

# 8

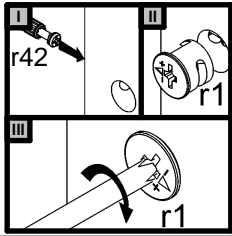
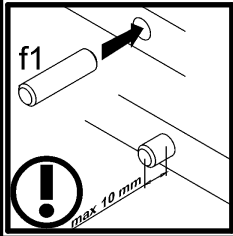
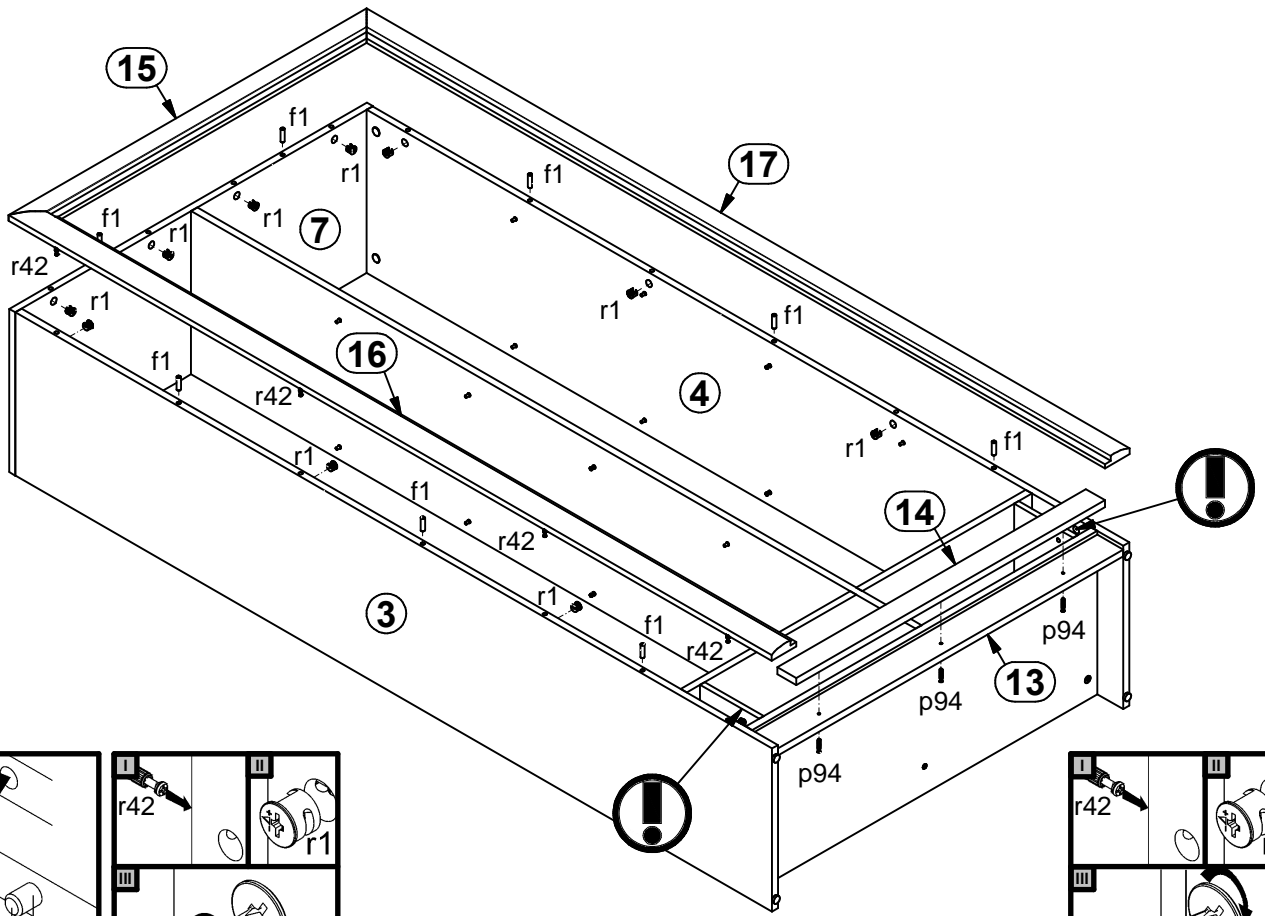

# 9

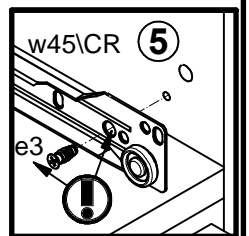
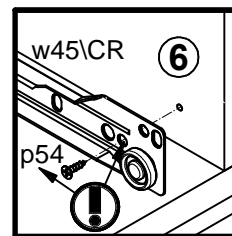
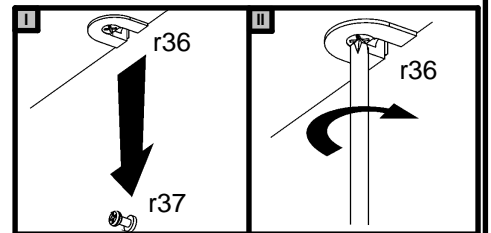
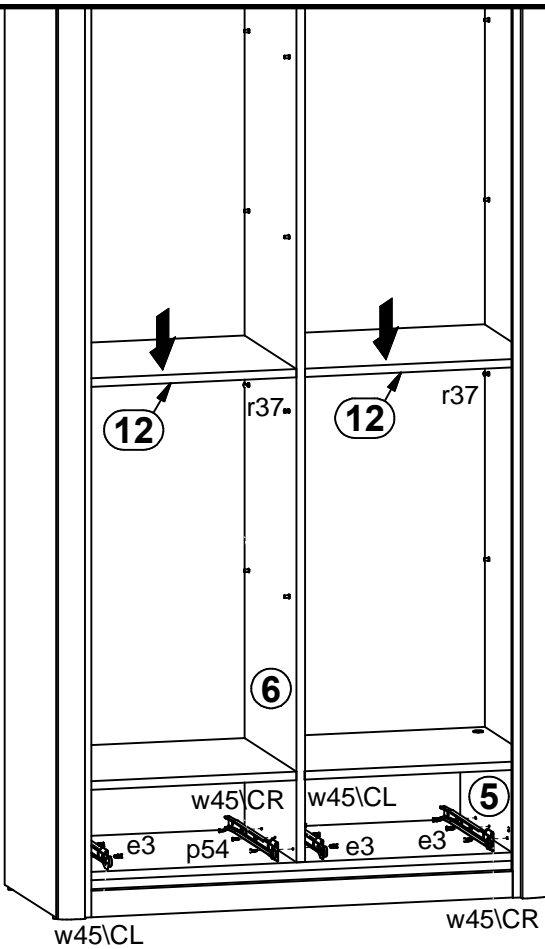

# 10

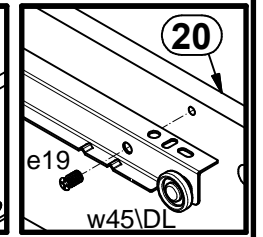
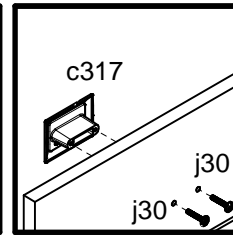
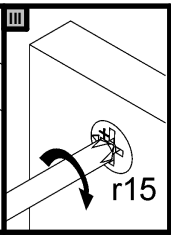
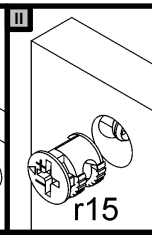
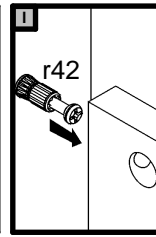
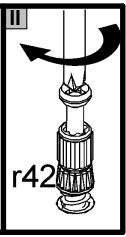
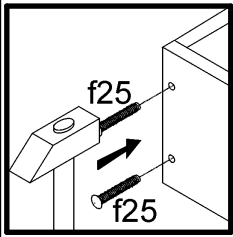
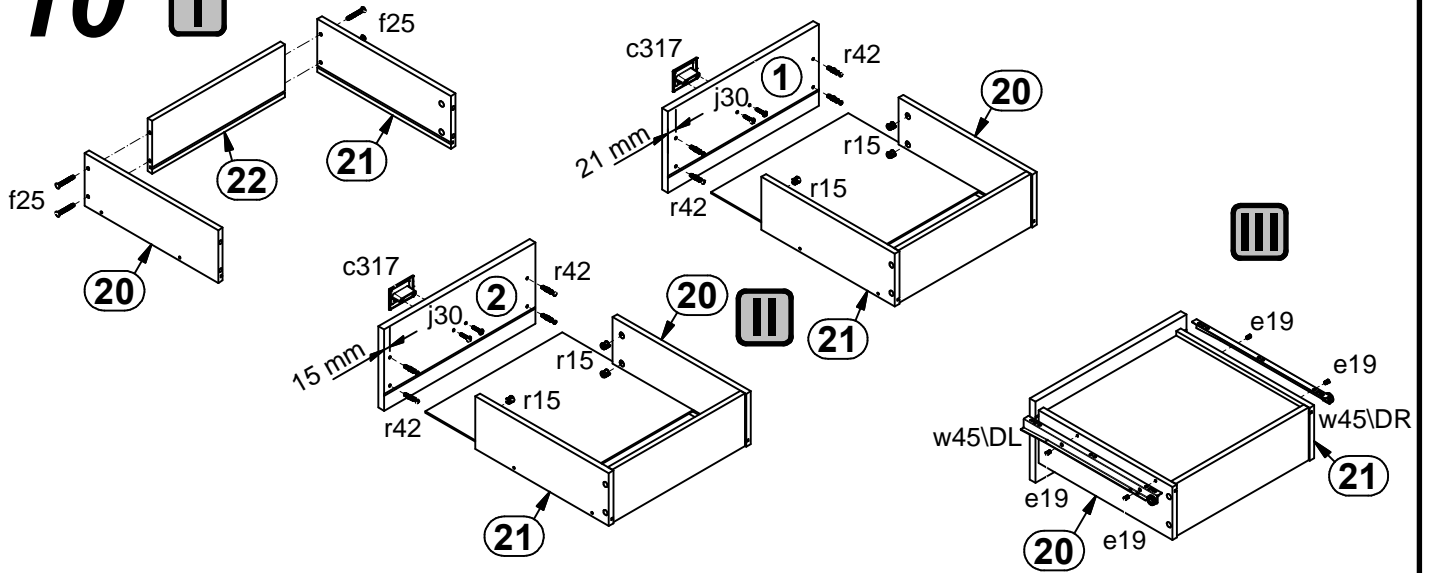

# 11

