

20.02.1351.00

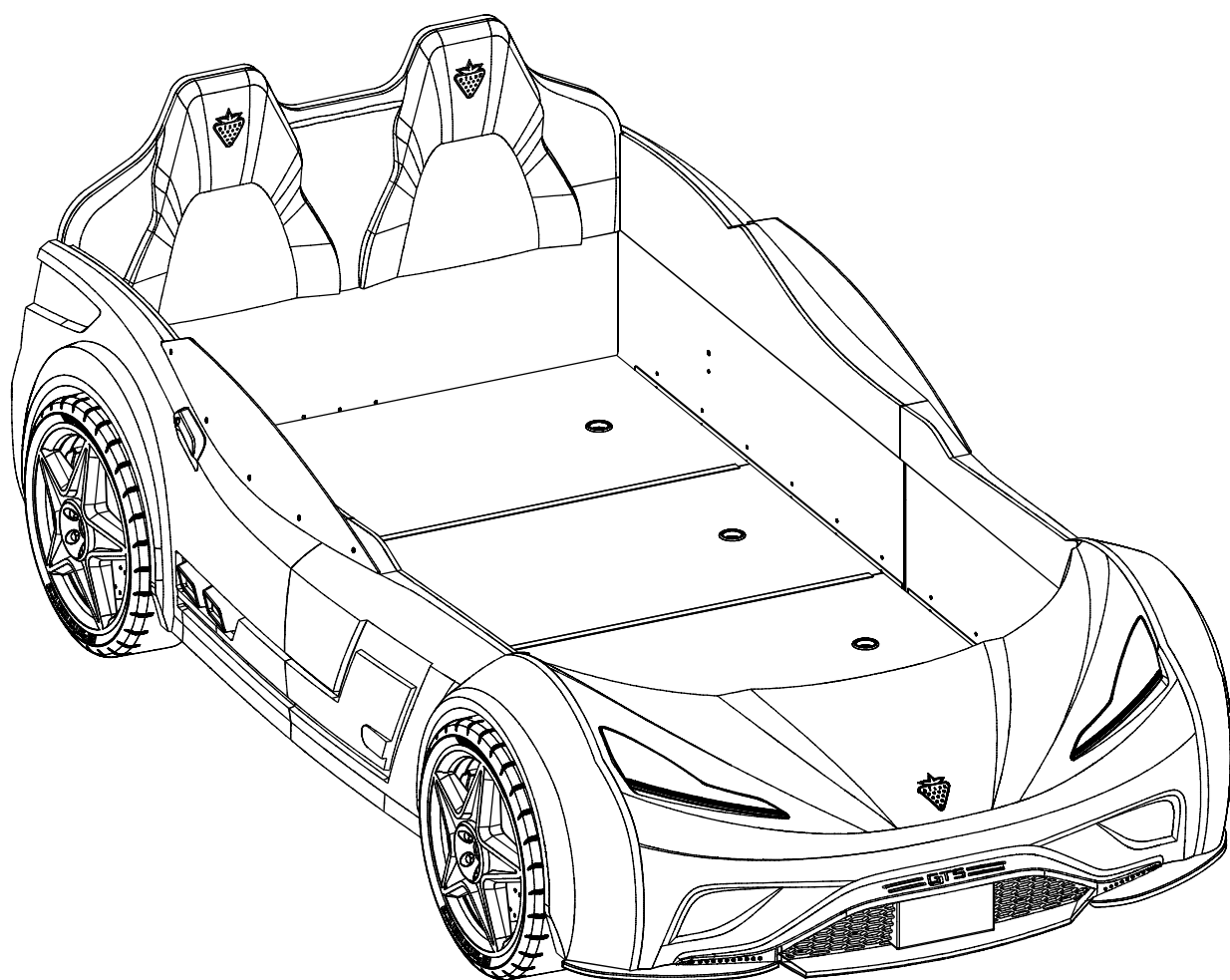

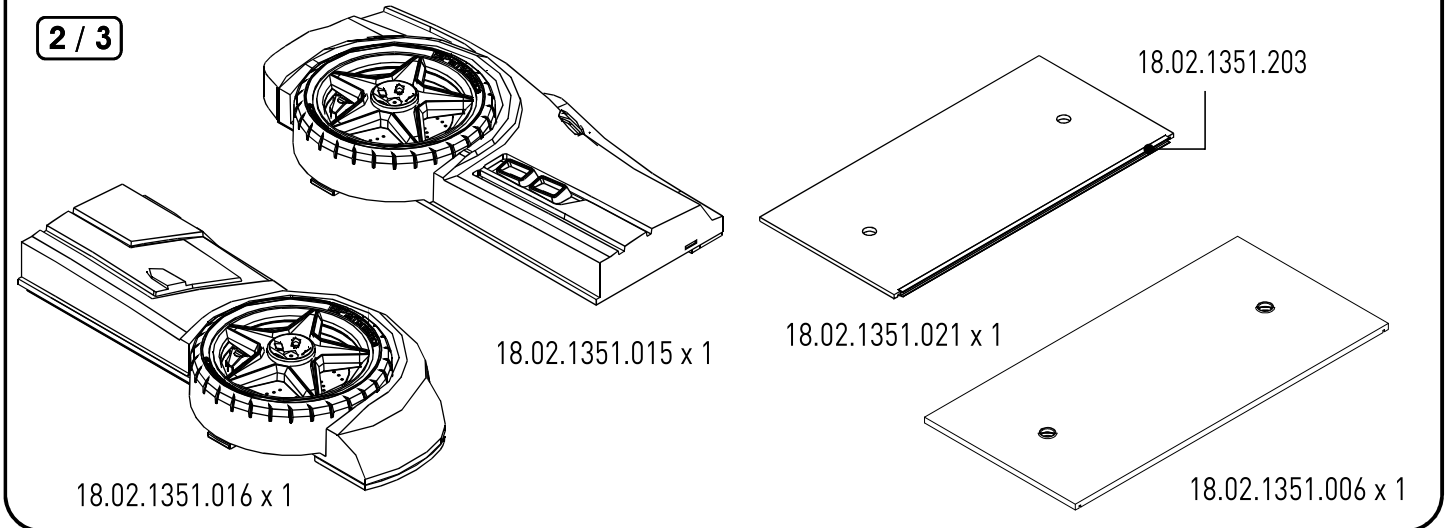

3 / 3

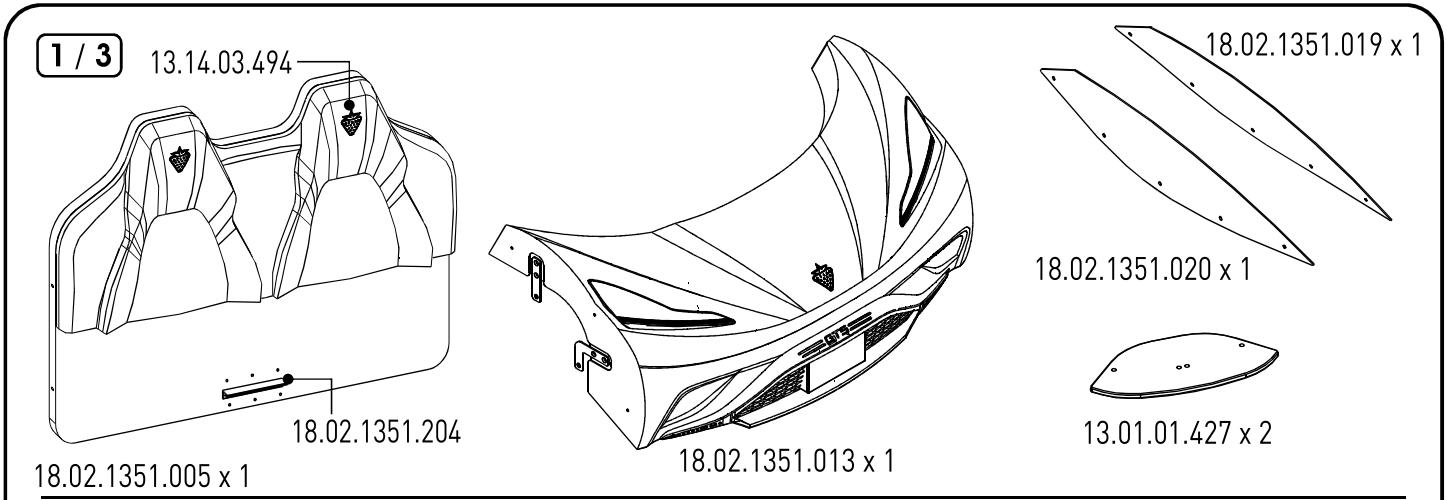
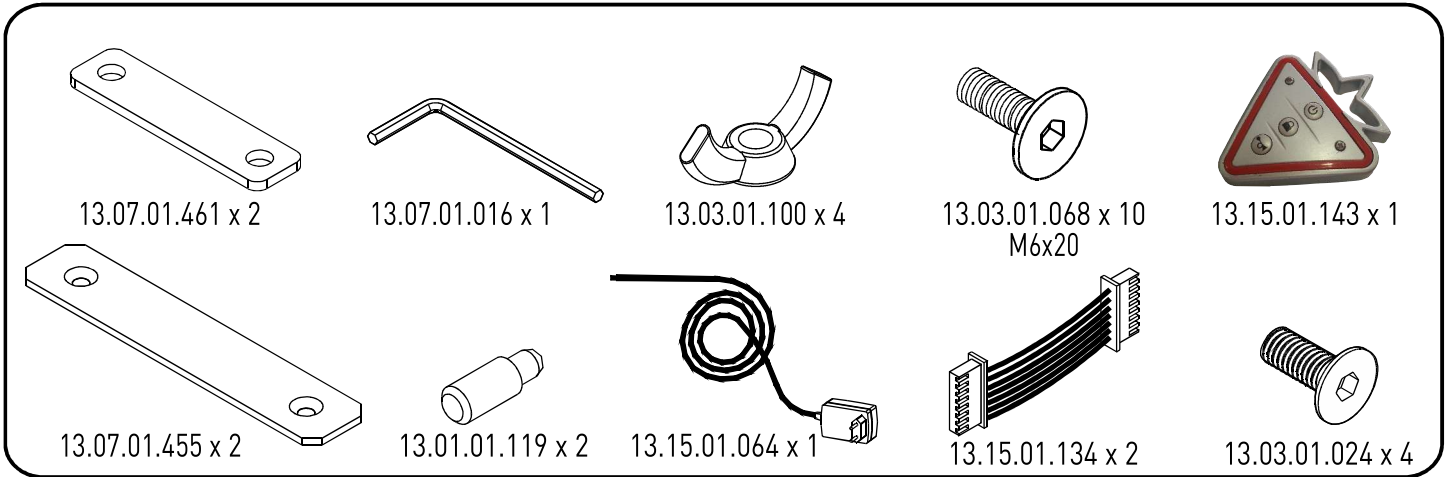
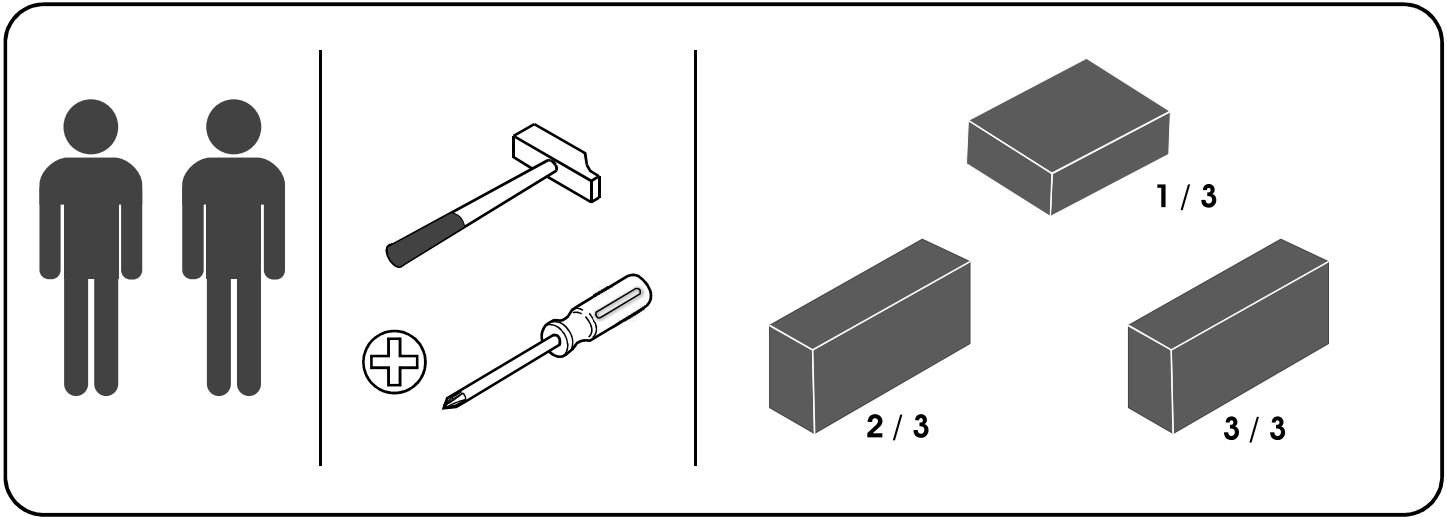
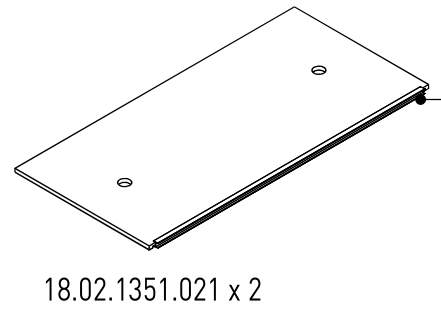
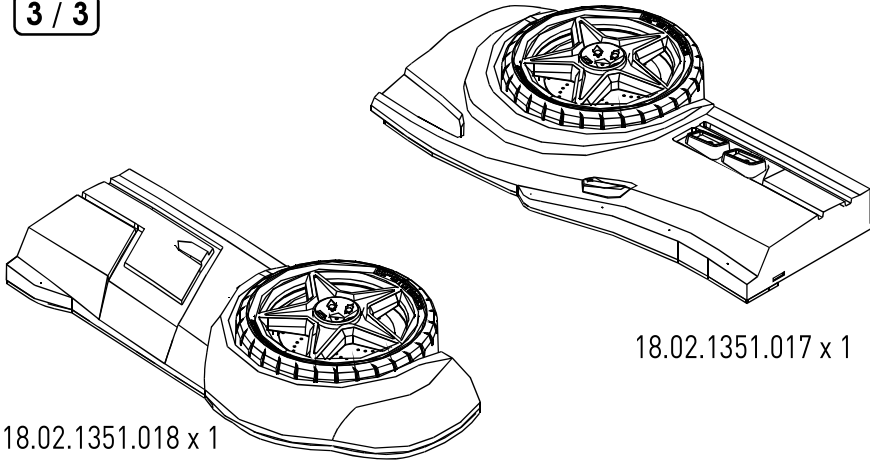

1

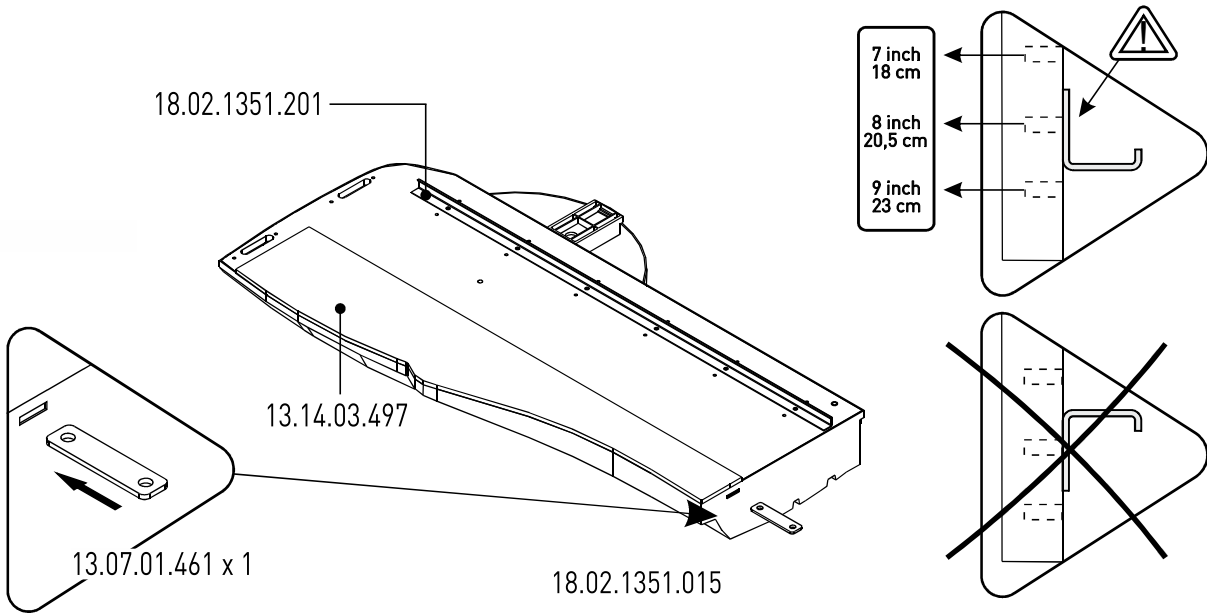

2

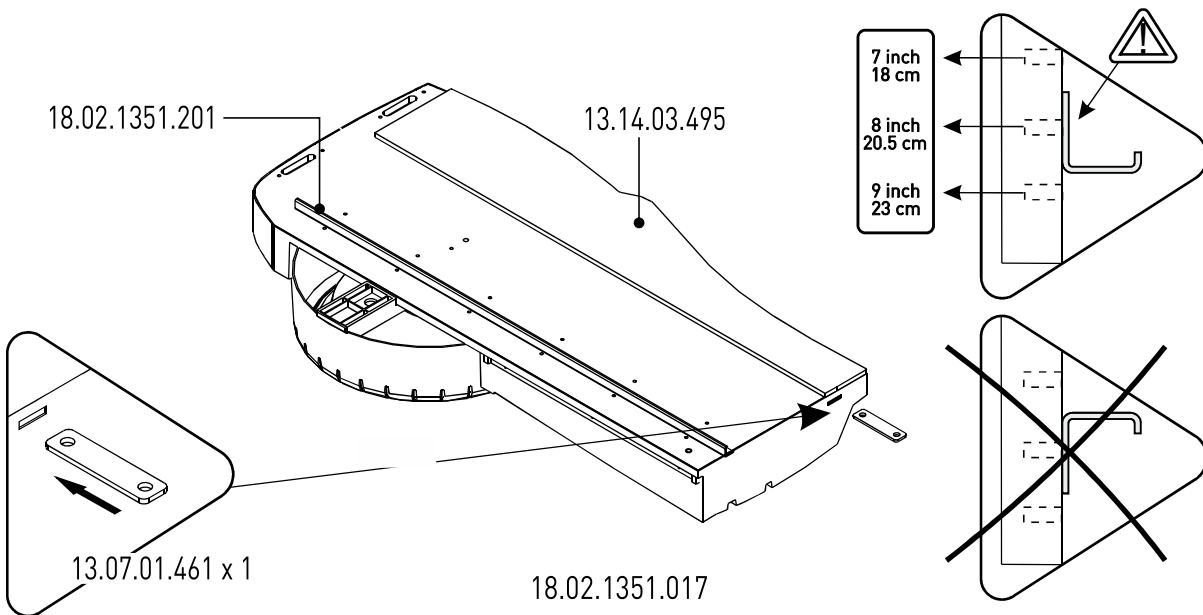

3

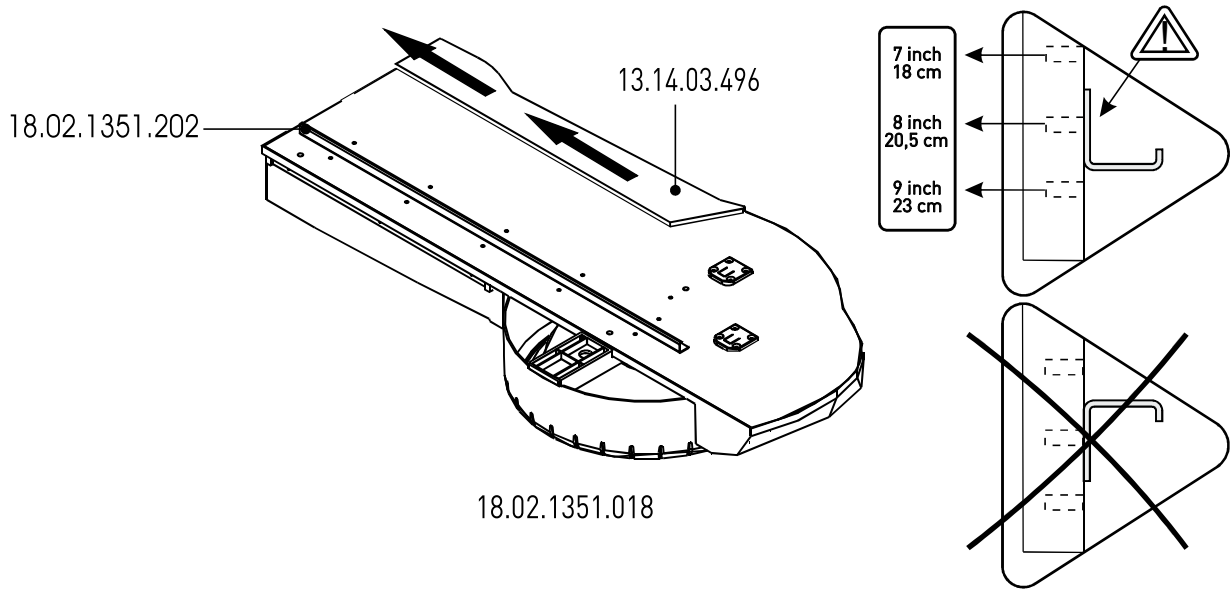

4

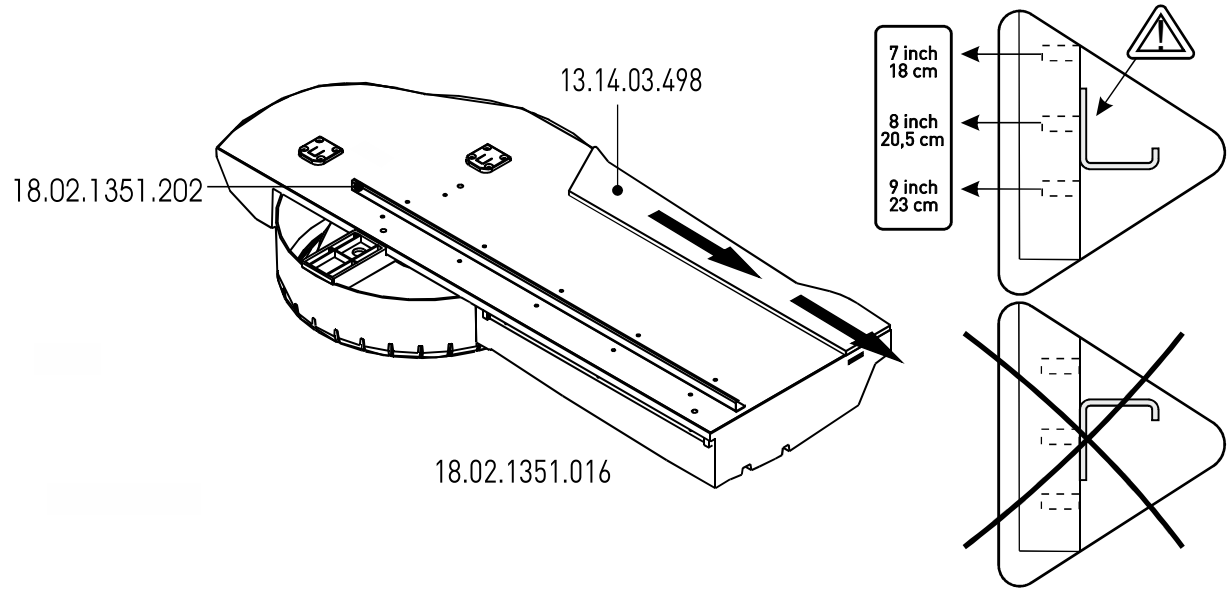

5

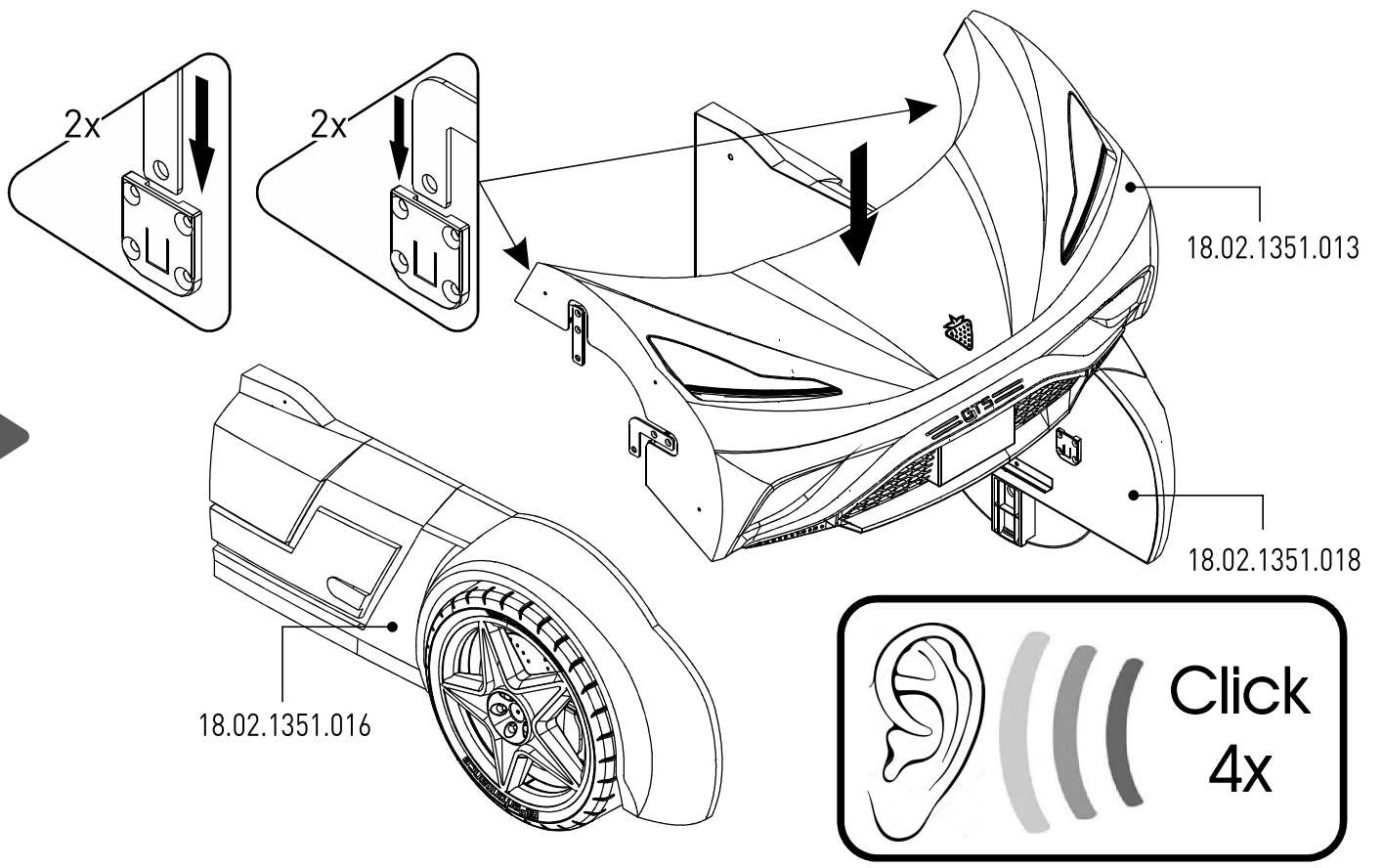

6

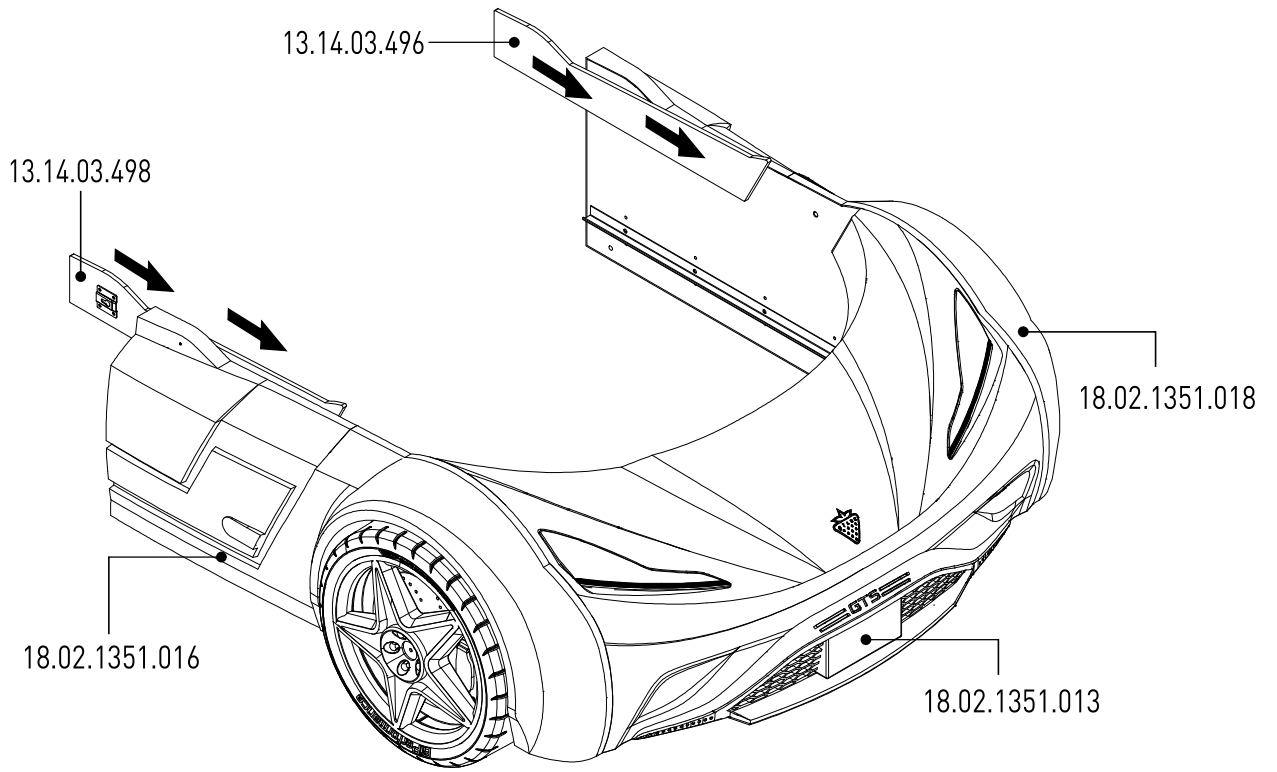

7

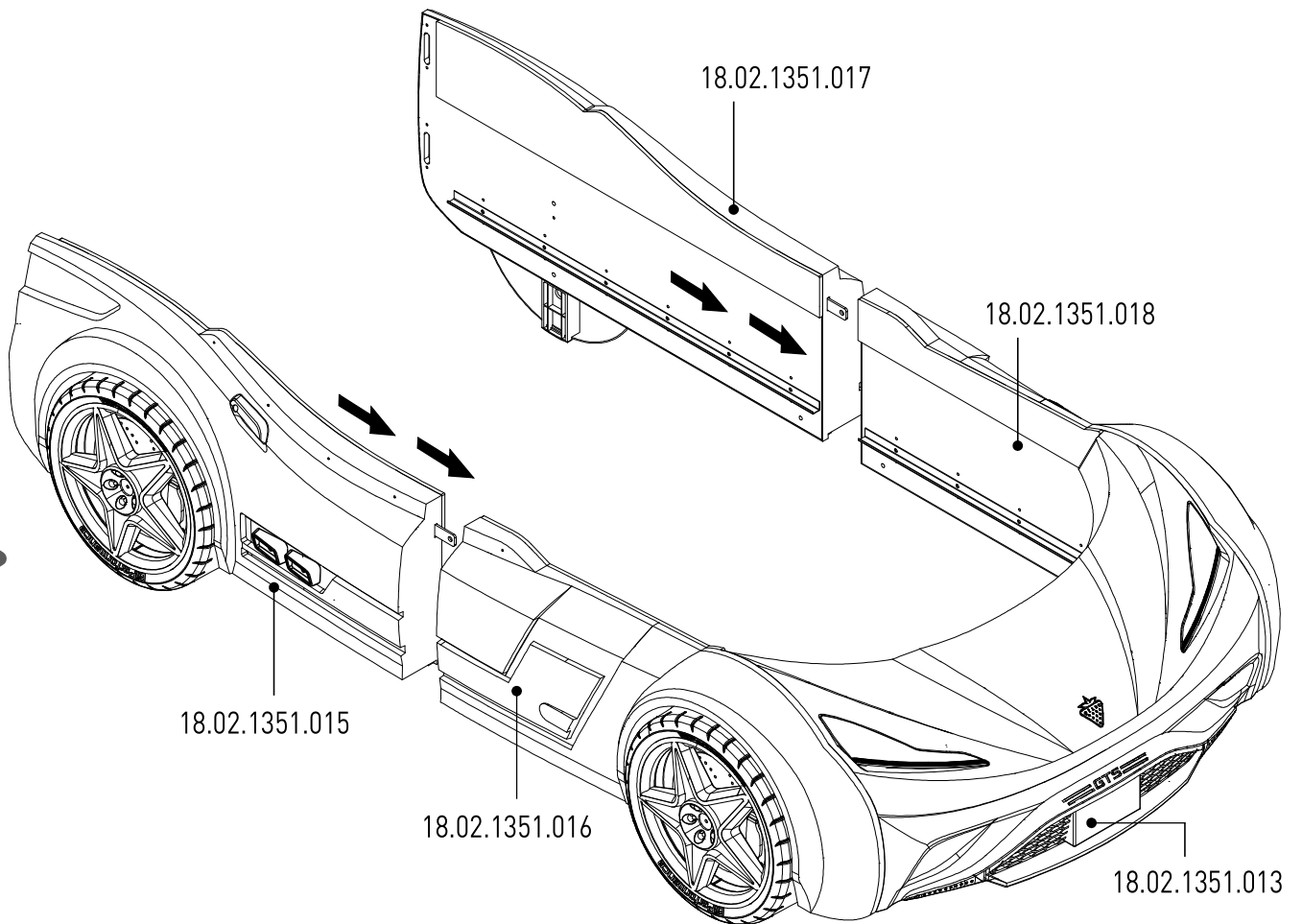

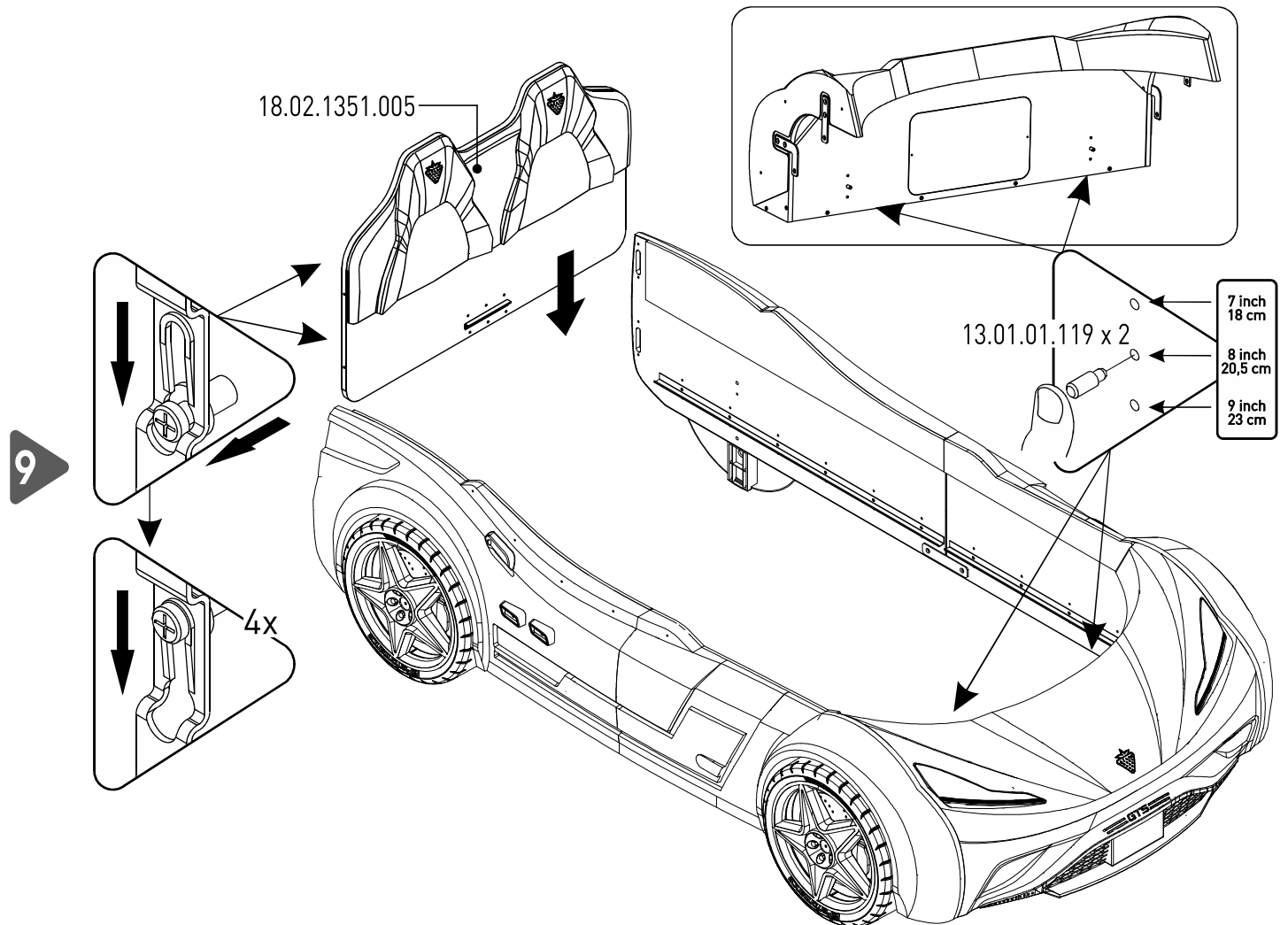
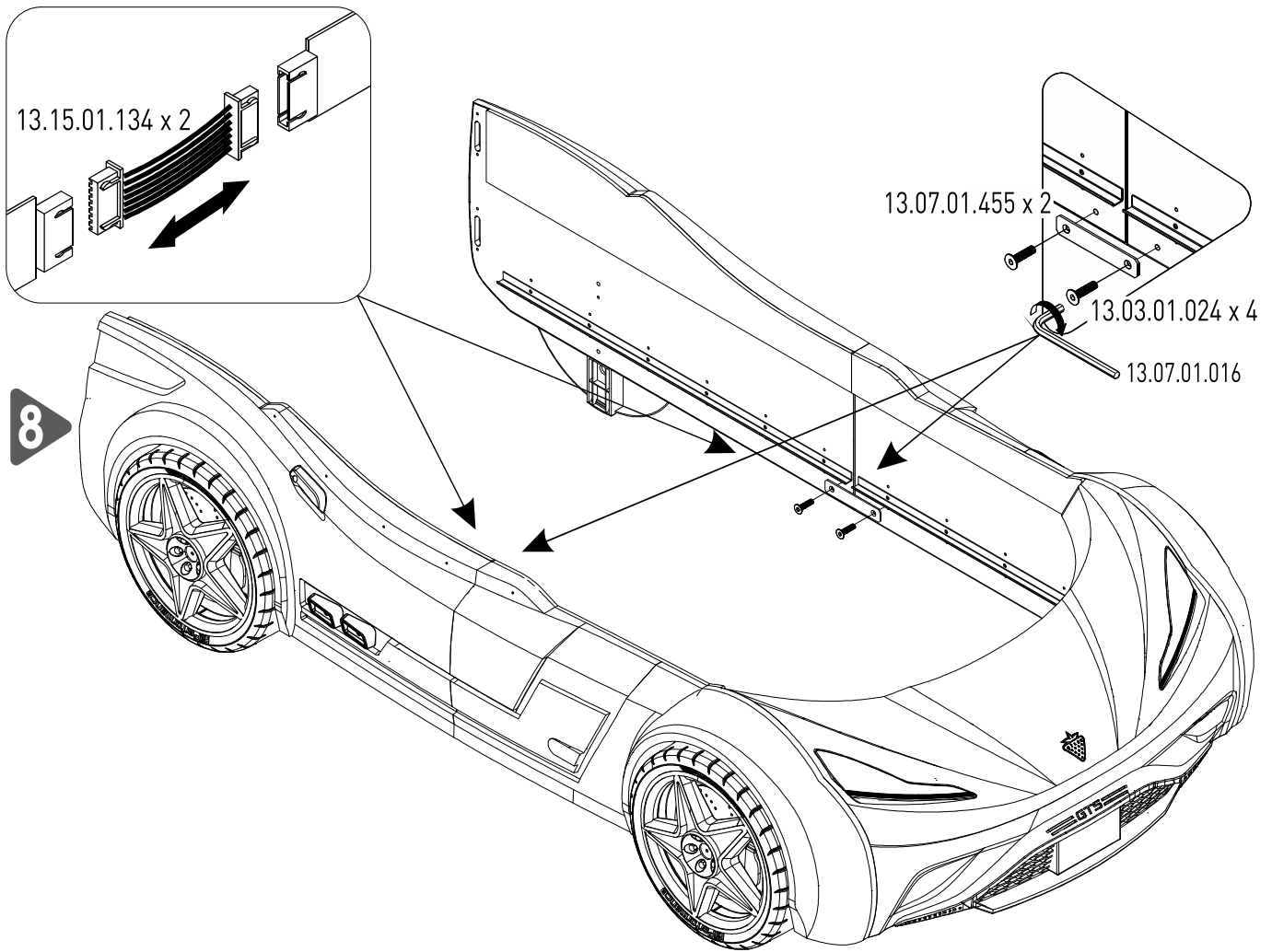

10

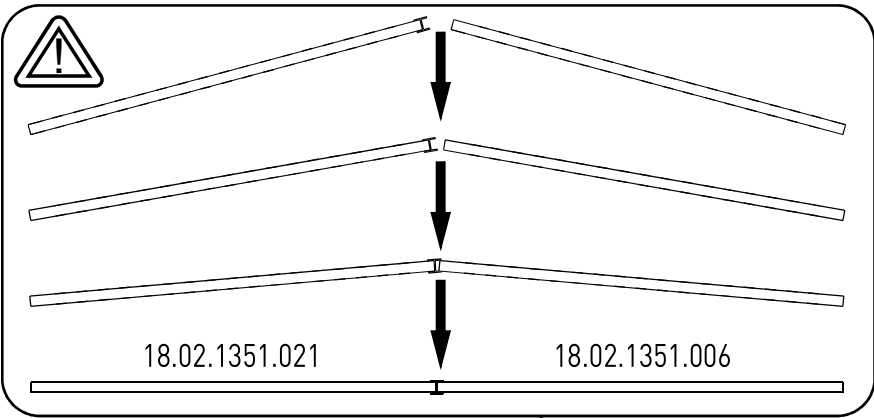
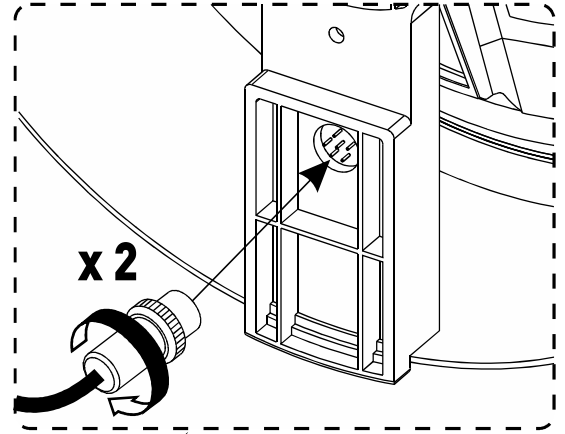
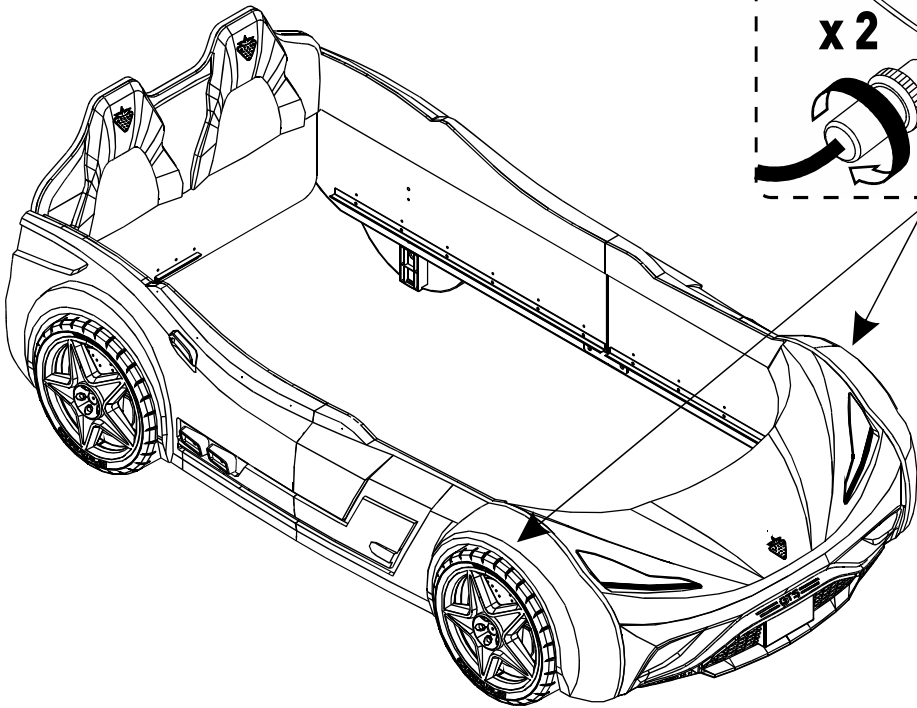

11

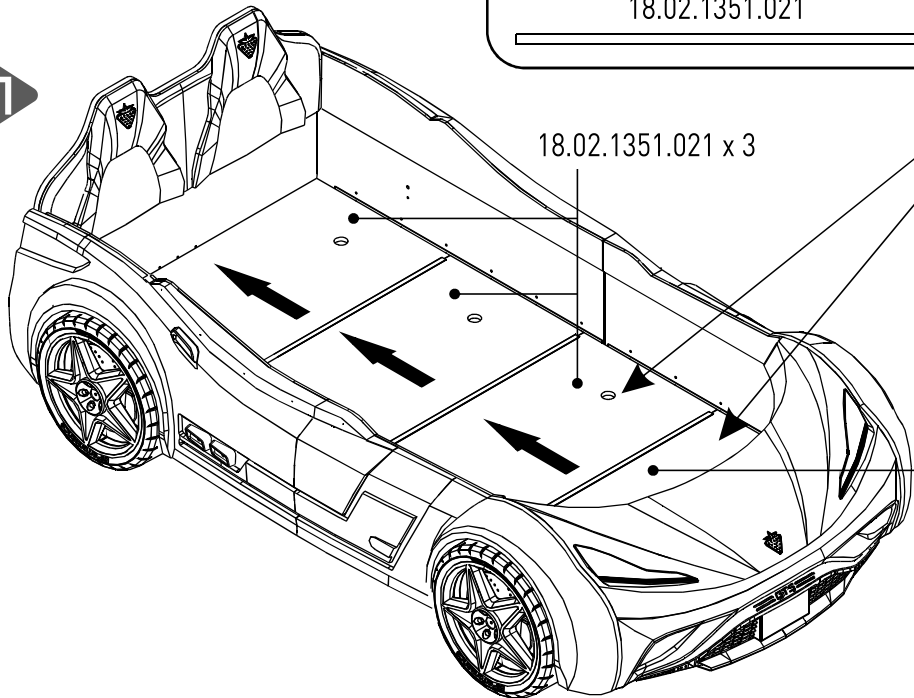

18.02.1351.021 x 3

18.02.1351.006 x 1

12

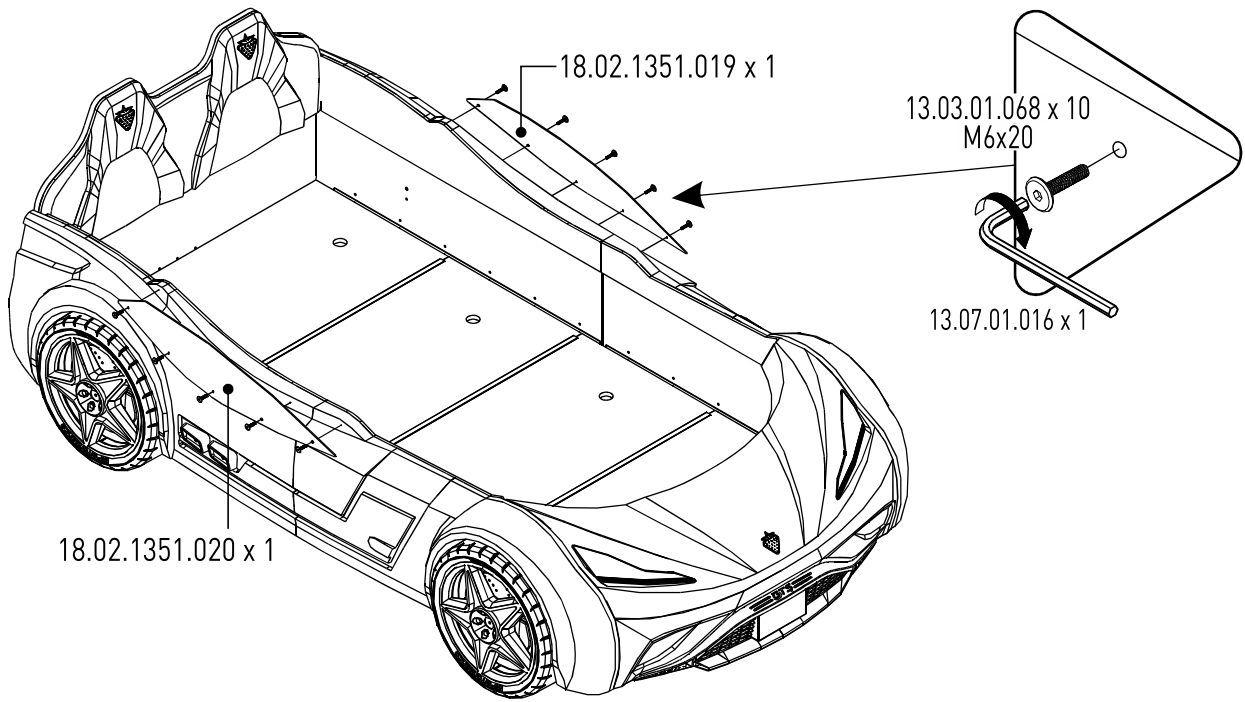

13

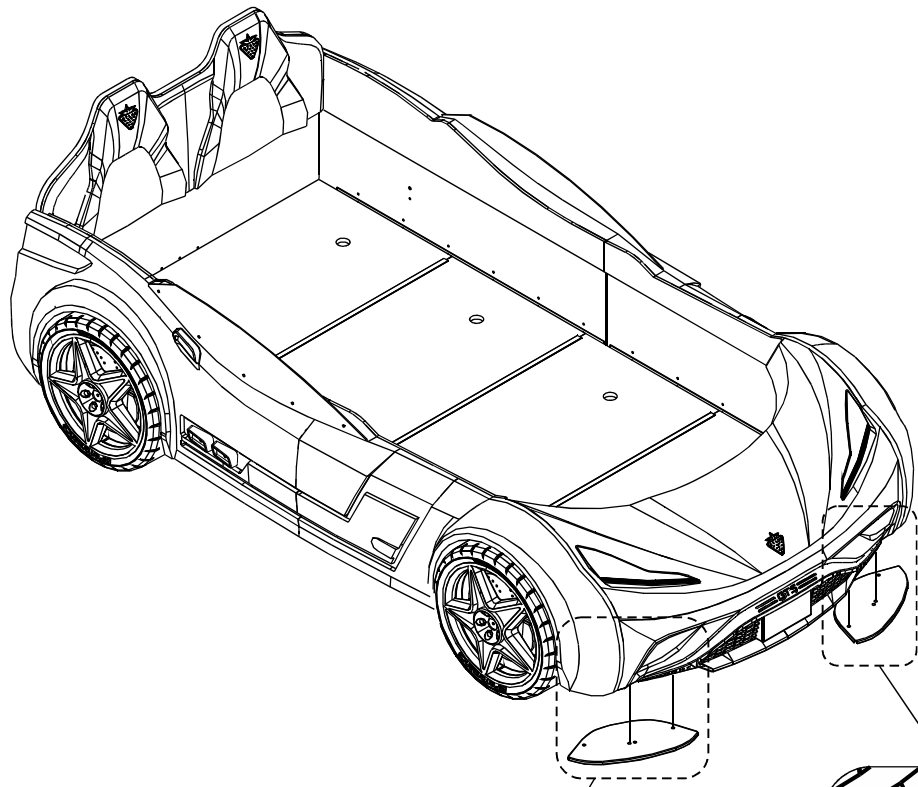

13.01.01.427 x 1

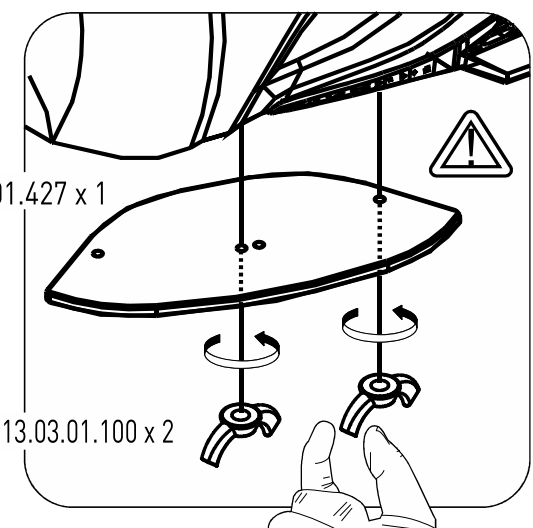

13.01.01.427 x 1

