

20.52.1102.00

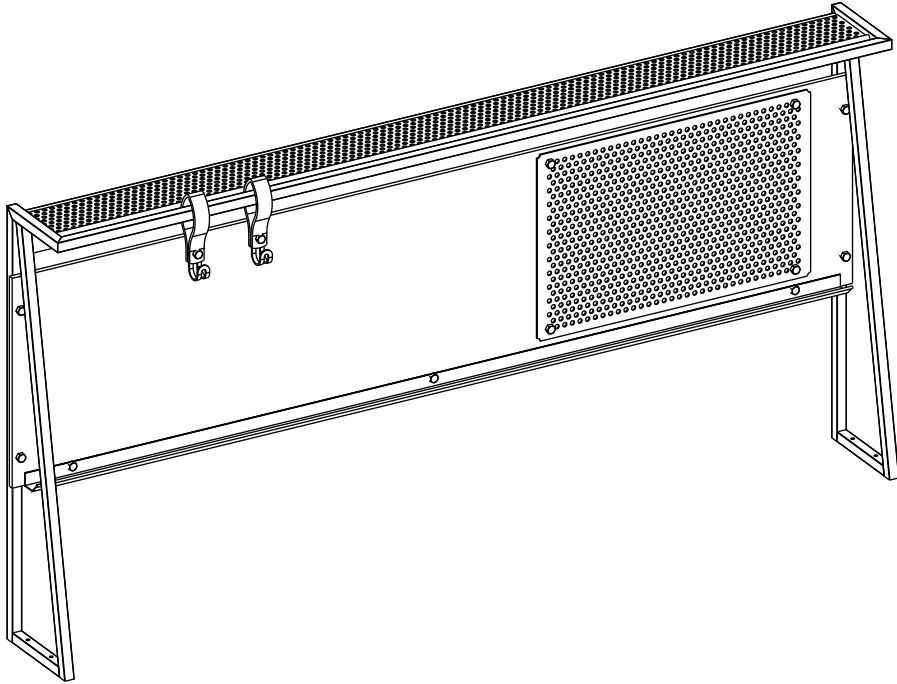

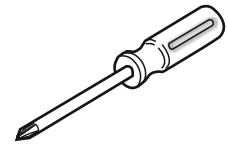

1 / 1

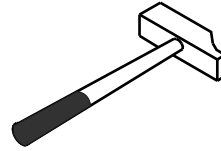
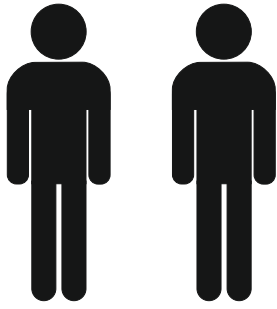
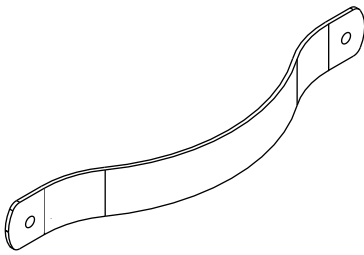

13.06.01.153 x 2

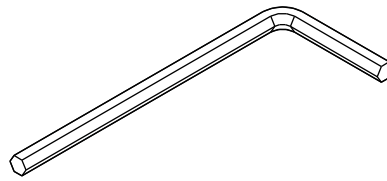

13.07.01.330x 1

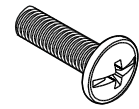

13.03.01.087 x 2
M4X13

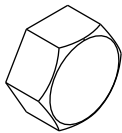

13.03.01.090 x 6

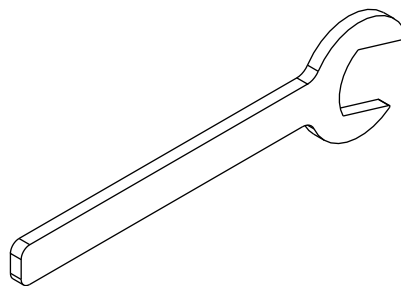

13.07.02.085 x 1

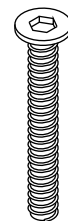

13.03.01.072 x 4
M4X35

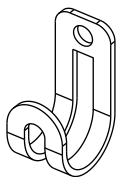

18.52.1102.211 x 2



13.01.01.559 x 1

1 / 1

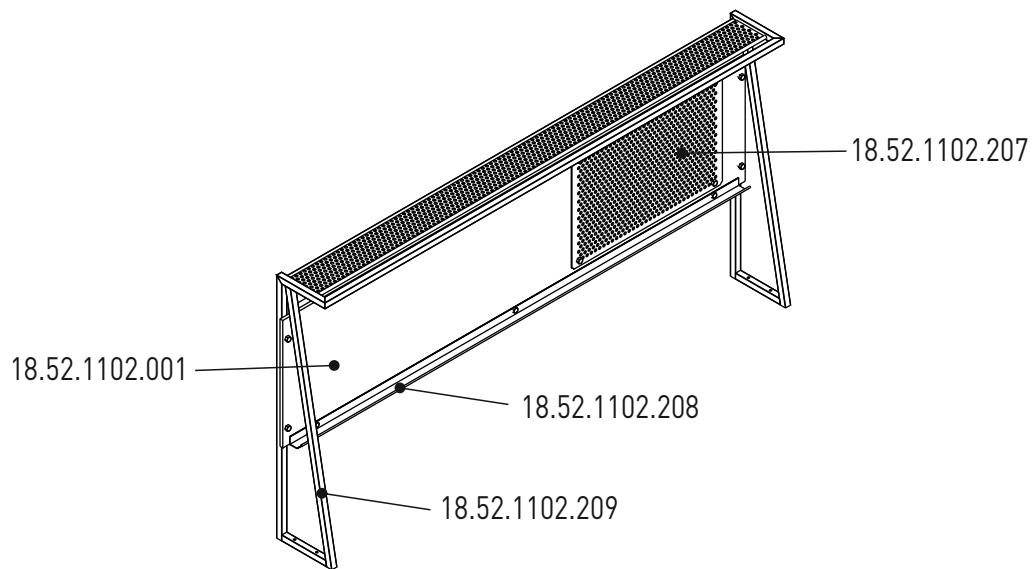

18.52.1102.207 x 1

